



Production Quality, Workers Safety

Problem: Lack of QHSE devices in Fabric industry



Quality Health Security Environment

70%



33%



10%



Solution-ViAFaM: Visual Automatic Fabric Marking

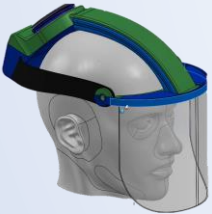
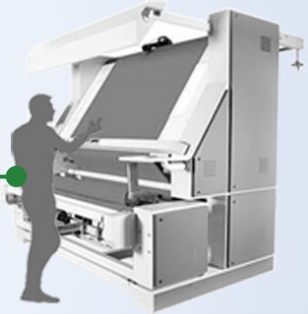
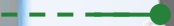

AmenAir

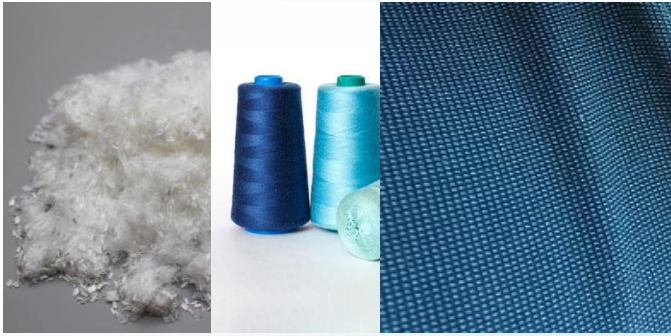

Polyster fiber



Spandex fiber



Acrylic fibers



Nylon fiber

Examples of synthetic fabric (petroleum)



Dataset Collection for AI



vizmerald

OK

Not OK

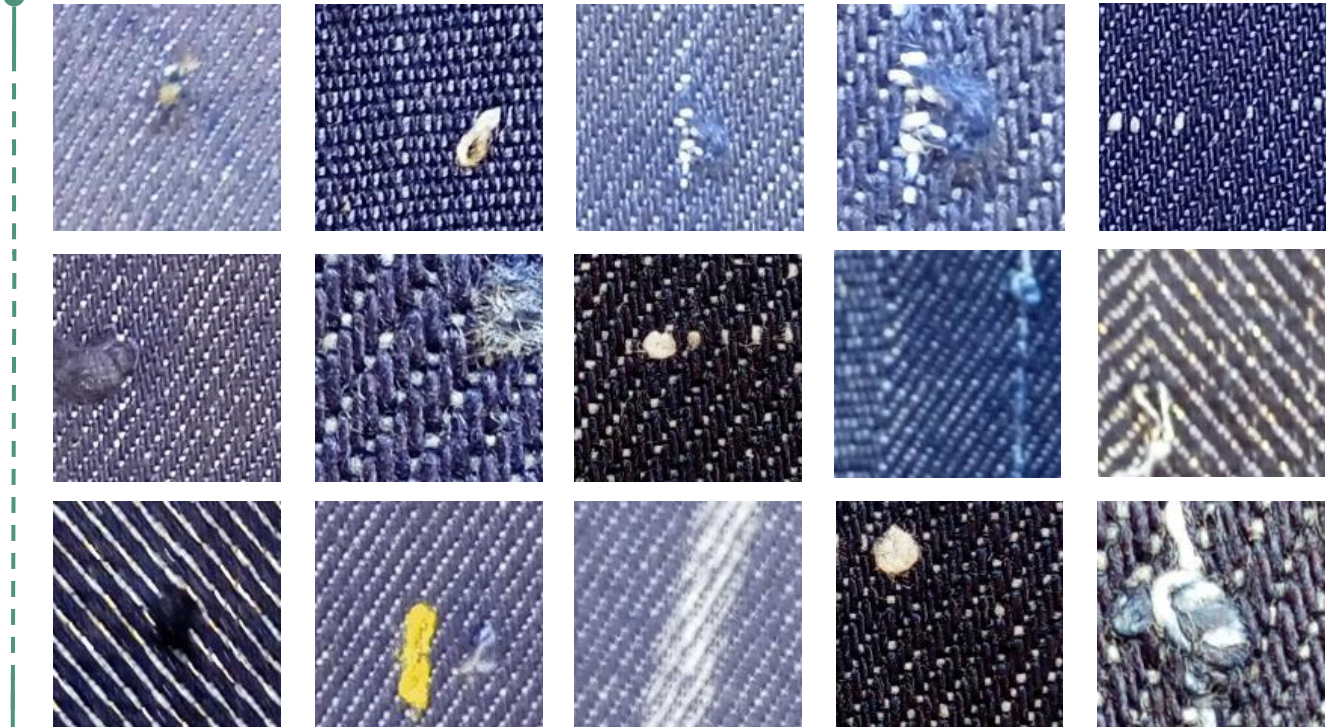

ViAFaM demo:

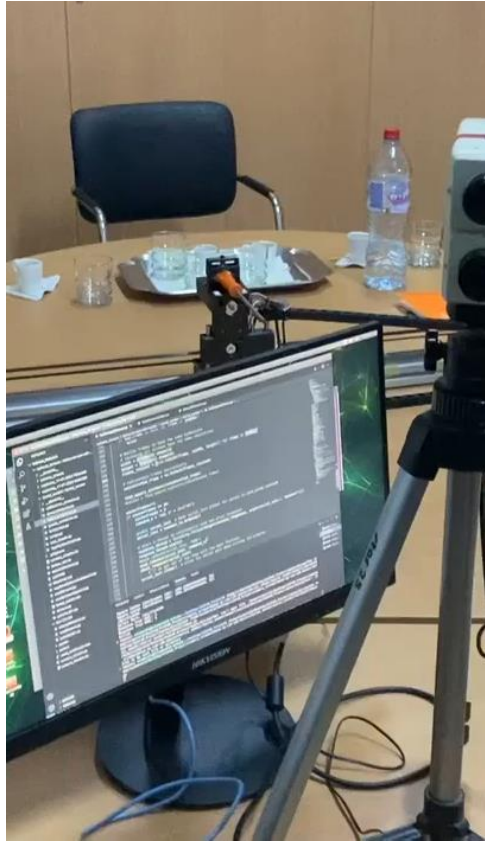
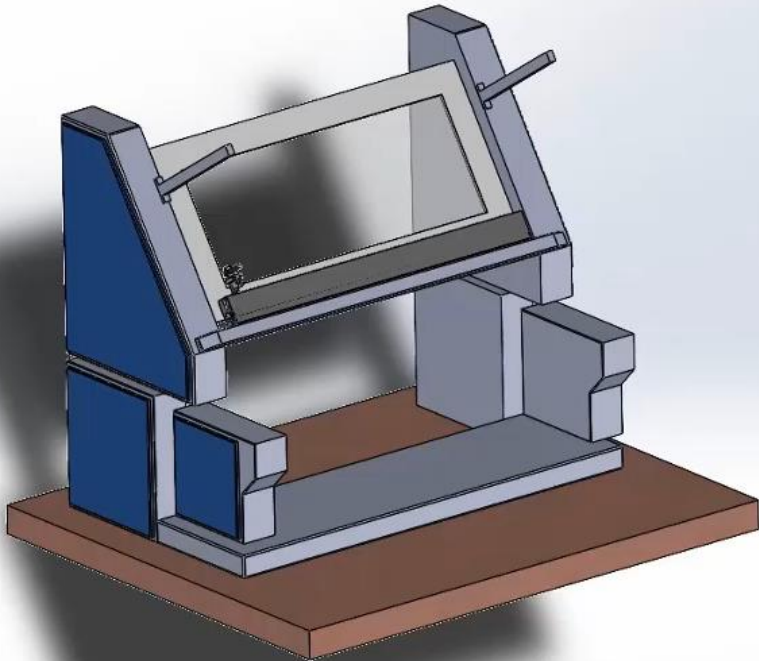

Competitors comparison



	Accessible	Adaptable	Affordable \$	
ViAFaM	✓	✓	<20K\$ (25%)	✓
USTER	✓	✗	> 100 K\$	✗
OSHIMA	✗	✗	> 85 K\$	✓
SERKON	✓	✗	> 60 K\$	✓



Market Positioning: QHSE

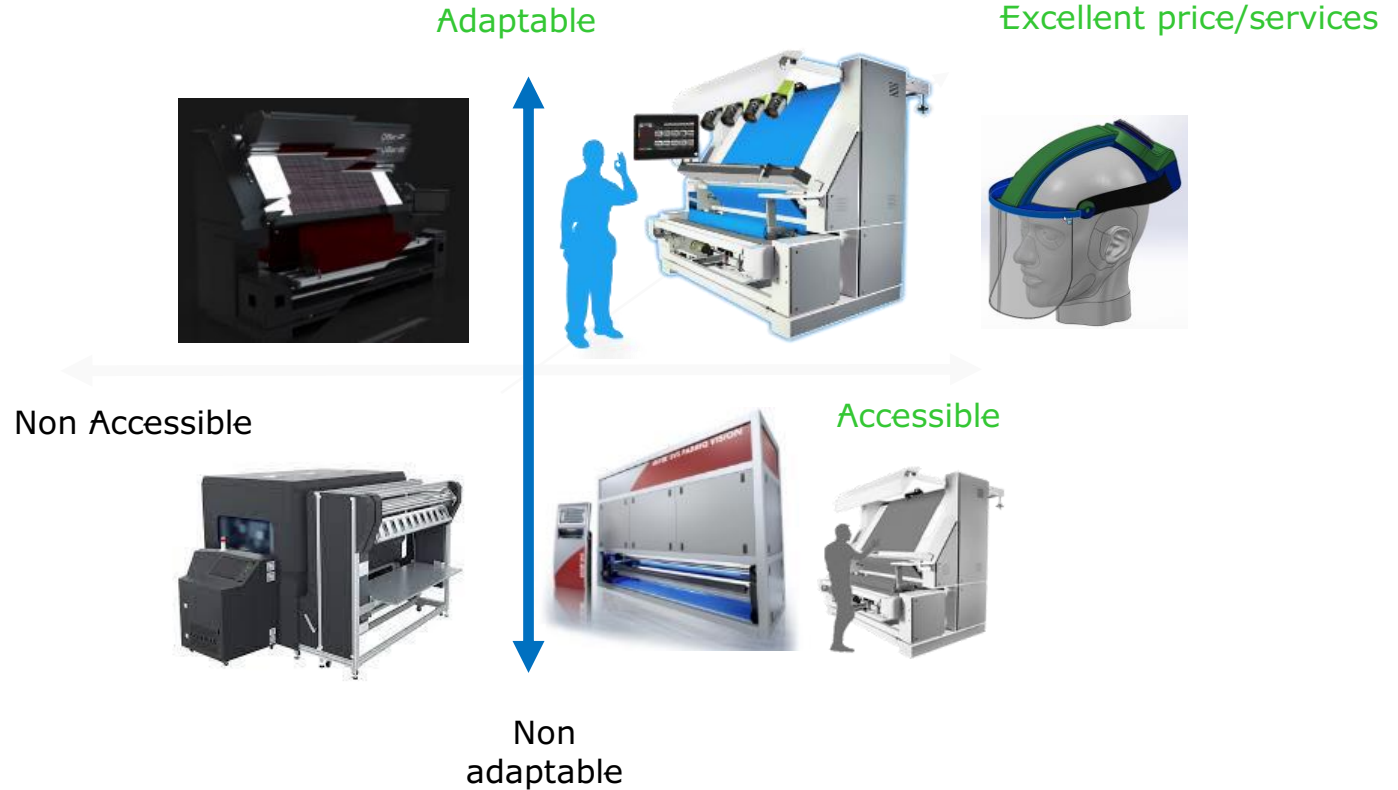

Problem (reminder): Lack of QHSE devices in Factories



Quality Health Security Environment

70%



33%



10%



Solution2-AmenAir: Air filtering helmet for industry workers

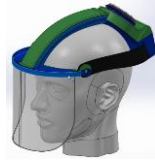
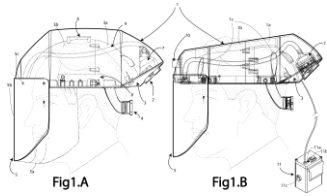

- Minimum weight of 350g thanks to an ergonomic plastic design
- Activated carbon air filters eliminate 95% of particles
- Available with closed or open visors in two sizes
- Battery life 8 hours at maximum speed
- Quiet 12V fan 32 DB max

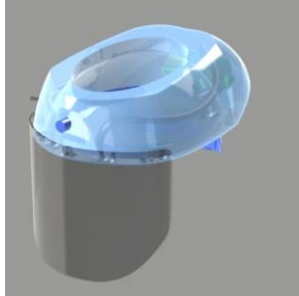

AmenAir Software: Web and mobile monitoring applications

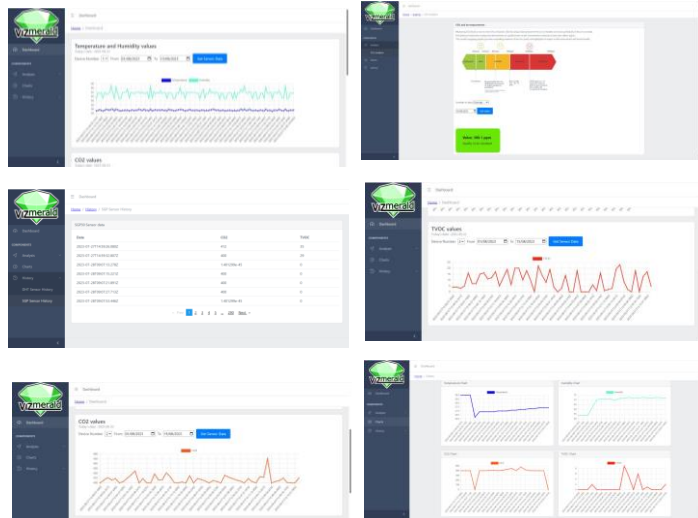

Interfaces d'accueil, inscription et authentication

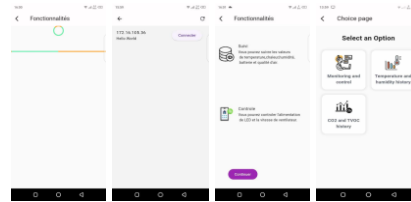

Interfaces de recherche Wifi et connexion aux fonctions de l'appareil

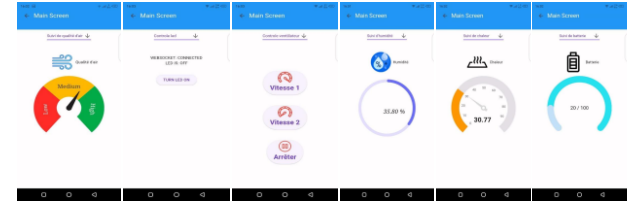

aces de surveillance et contrôle des appareils

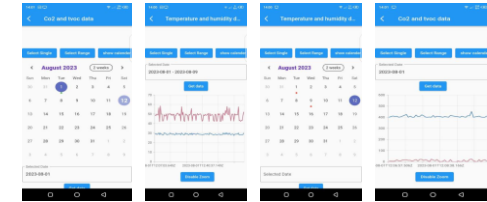

Interfaces d'historique de température, humidité, Co2 et TVoC depuis Cloud

Check our online cloud platform hosted on Amazon AWS

<http://amenair.vizmerald.com:4200>

Air filtering Market Size: Global Estimation 91B\$



- MENA region still free of actors
- Asiatic region at the most need
- Actors:

IQAir

- Air quality filtering worldwide
- Monitoring app

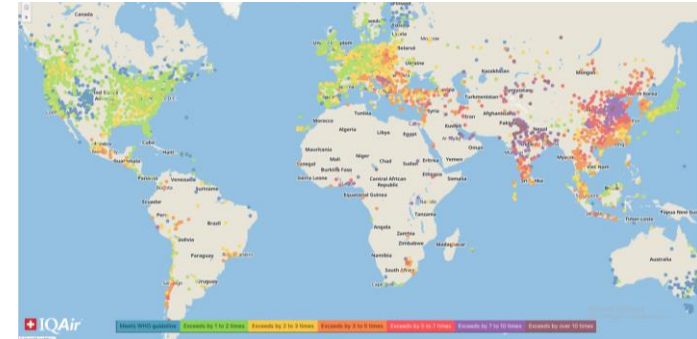

Dyson

- Protection wearables
- Mobile app



3M, Dräger, Honeywell, ...

Personal test of the Dyson headset in Dubai
Appeared on the global market only 2 months ago!

TAM & Market opportunity



Global Textile Market

\$195.36 billion in 2026

Evolution rate of 6 to 8%

\$195B

\$31B

\$2B

Local Market (MEA region)

250 Textile factories (Tunisia)

41% of labor force (+200K workers)



Business Model



Visiting Machine
IA addon

20K \$
per unit

250 x 50K \$ = 12M \$ (year)

Freemium
software

Software Annual
Subscription

3K \$
per year

500 \$ per month

AmenAir

200 \$

++

Team



Bassem SEDDIK
Ph.D., M.Sc. IoT
CTO



Yosra YAHYAUI
Business Dev. & Com.
CEO



Melek CHRIF
Polytechnical engineer
Tech. Lead



Zahra BOUKAMCHA
Electrical Aut. engineer



Yasmine CHAYEB
Front End Dev. Technician



Iyed BEN AICHA
Computer vision engineer



Zakaria ROUATBI
Software Dev. Engineer



Roua REJEB
Adv. Tech. Engineer



Ameni HABOUBI
Patenting & Com. Master



Roadmap & Ask

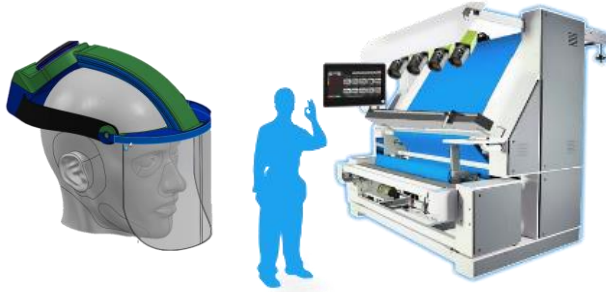

Q1 2024: Promote



Q2 2024: Package



Q3 2024: Scale

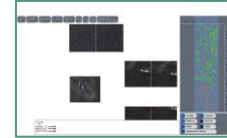
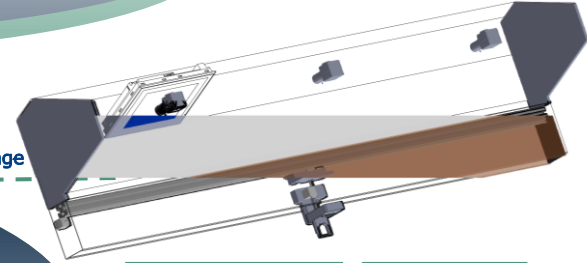

Perspective: AmenAir smart 4.0

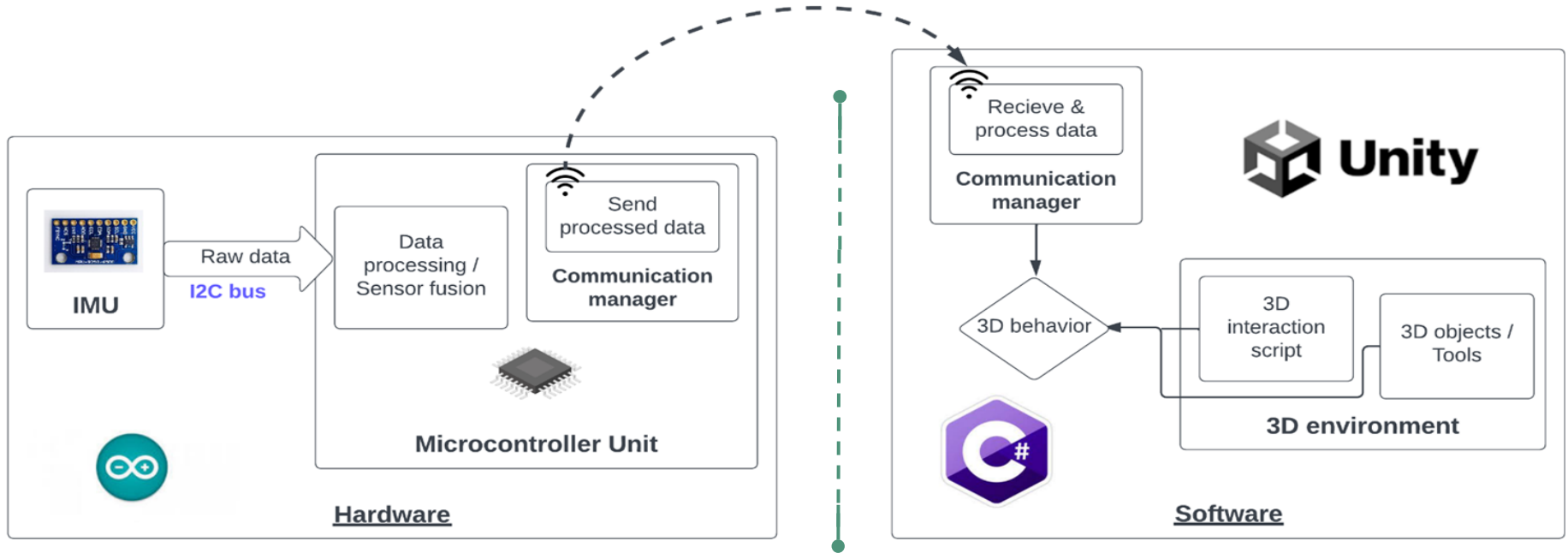

Partners & Facilitators



INCEPTION PROGRAM



العربية للإتصالات
مركز للتكنولوجيا

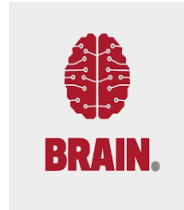



Production Quality, Workers Safety

www.vizmerald.com

contact@vizmerald.com

CREDITS: This presentation template was created by SlidesCarnival and includes icons by FlatIcon and infographics & images by Freepress.